

HAVAL

HAVAL H6 GT

NEW-GENERATION STYLISH & SPORTY SUV



we're here for YOU





Awaken multi-faceted life

Life is like a game; there are as many kinds of life as there are ways to play

Stylish appearance with sporty performance

Lighting up passion with lightening speed

Switch modes at will and control your life game by yourself

New-generation stylish & sporty SUV



"Black Shark Aesthetics" design language Sporty styling leads a popular trend

Inspired by the Legend of the Deep Sea, the "Black Shark Aesthetics" design reshapes the classic and spearheads sporty styling, becoming the focus of attention everywhere it appears



Fluid aesthetic

The innovative streamlined body design stimulates the design potential of the Coupe SUV, and brings improvements in both appearance and performance



■ Shark pectoral fin-shaped front and shark teeth-based parameterized air intake grille allow the vehicle to present stylishness and sharpness



■ Sleek contour waistline delivers a strong visual impact, stimulating your imagination



■ Double rear trim spoilers adjust air flow distribution and increase downforce, with stronger stability at high-speed driving; optimized vehicle structure, reducing wind resistance and improving stability



■ Streamlined roof with fastback design effectively reduces wind resistance



■ High brightness LED matrix automatic headlamps light up your journey ahead

Practical aesthetics

Outstanding width and height ratio helps create a luxury and roomy space

 4727 mm length, 1940 mm width, 1729 mm height, 2738 mm wheelbase and 1640 mm rear track, stylish cabin



 Wireless charging



 Contrast-color stitching conveys dynamic charm



 *Inductive electric tailgate, with a maximum trunk* volume of 1390L



Stylish & sporty SUV

Your first choice of driving control performance

With excellent performance in speed and control, the stylish vehicle demonstrates powerful performance in a real sense



High-efficiency 4N20 engine

With high-efficiency GWM 4N20 engine and upgraded 2.0GDIT turbocharging technology, the vehicle has thermal efficiency of 38%, maximum power of 150 kW and maximum output torque of 320 N·m at 1500 r/m



Second-generation 7DCT Wet dual-clutch transmission

With a low-leakage hydraulic control system, the vehicle has a comprehensive efficiency of 95.6%, anti-misoperation of P gear, anti-theft function and clutch pressure control response time within 100 ms, making it efficient, cost-saving and reliable



Professional tuning

With lowered (by 10 mm) center of mass, suspension posture, and front McPherson and rear multi-link suspension structure, the vehicle features accurate steering control and sensitivity during braking, accelerating and turning at a high speed

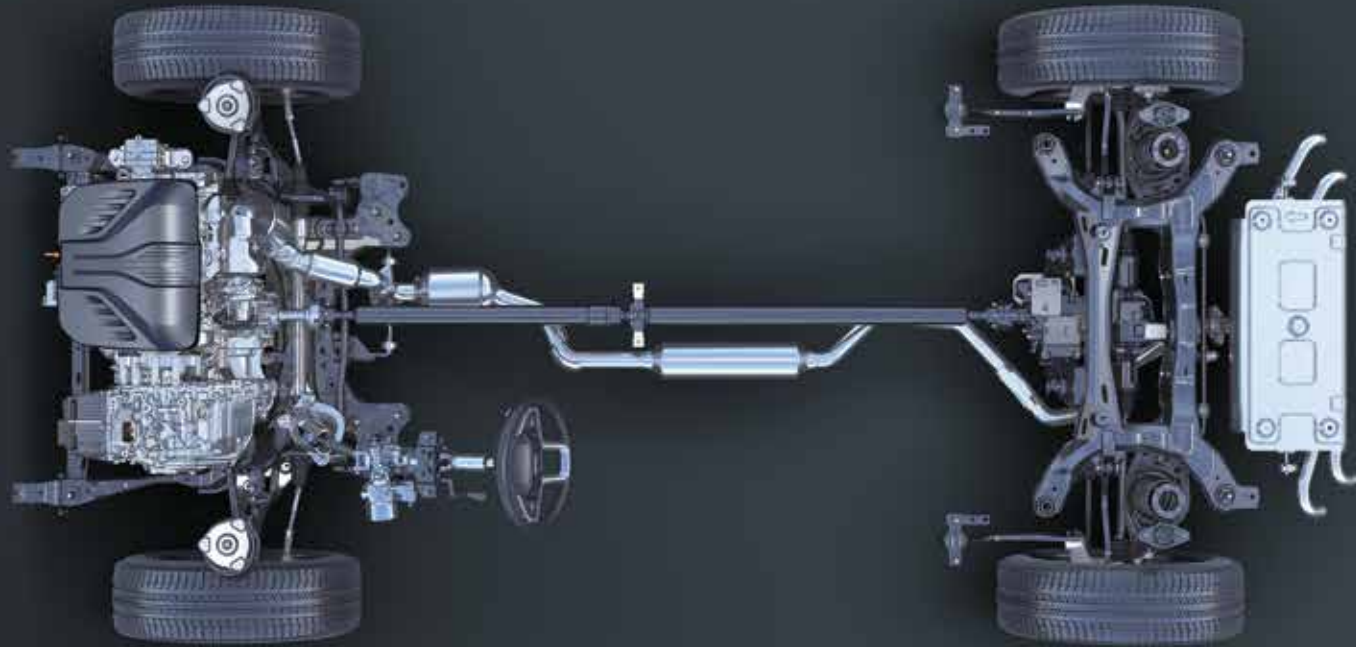

Enhanced performance

With the shape design of a sport coupe, the vehicle is able to stimulate your desire to drive with its track mode and exhaust sound wave system



 Excellent acceleration performance



 Track Mode + Exhaust Sound Wave System

 More sporty atmosphere with contrast-color shift knob

 *Free switching of 7 driving modes, including Standard/Sport/ECO/Snow/Sand/Off-road/Track, enables the vehicle to handle various road conditions easily



*Only 4WD standard configuration with seven driving modes





Start off with both advanced EQ and IQ

Break traditional boundaries with innovative design to cater to the new urban life

Intelligent driving

Equipped with high-computing power chips, it resonates with young people's personalized intelligent travel needs, and is truly a smart brain



 ACC+ICA+TJA full-speed self-adaptive cruise control

 Front sensors and parking sensors

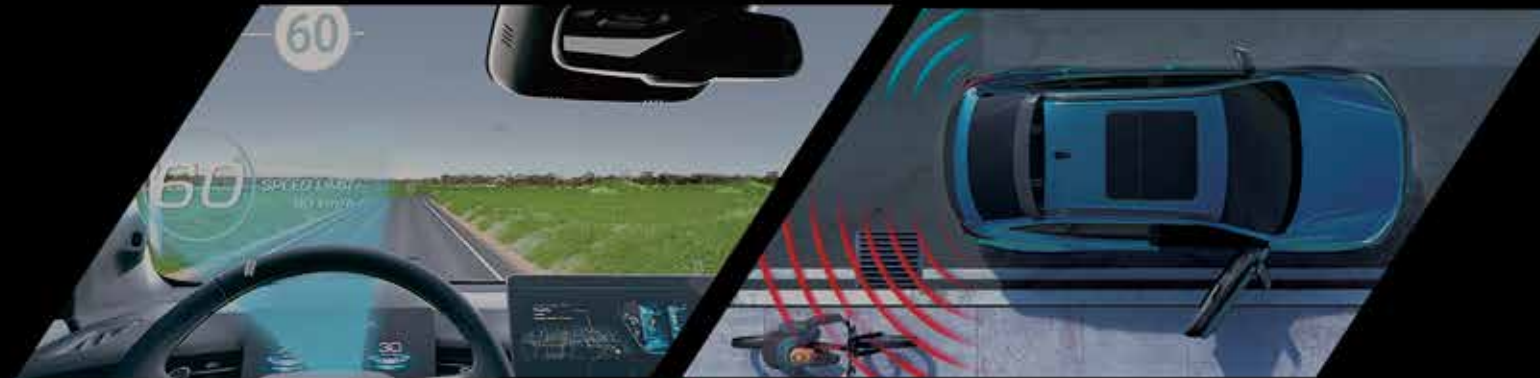



 Traffic sign recognition (TSR)

 Door opening warning (DOW)

Intelligence makes the difference

The user-centered, intelligent and healthy safety cabin, intelligent safety and advanced smart driving provide you with pleasant driving experience

 Dashboard UI displaying the percentage of power and torque + 10.25" digital screen

 Fully automatic fusion-based parking assist system



 Reverse path-tracking

 360° panoramic view

 HUD full-color head-up display

 12.3" colored multi-touch screen



* The display size of HUD visual is provided for reference only, subject to the actual vehicle
* The above configurations are not for standard configurations of all models. See the product configuration list for details



Active and passive safety protection combined Provide safe, worry-free driving experience

Interior and exterior protection ensures safe driving in a secure manner
More secure travel along the way



Super protection

72% application proportion of high-strength steel and the maximum press hardened steel tensile strength of not less than 1800 MPa create a movable fortress to protect the safety of driver and passengers at all times



- Mild Steels (MS)
- High Strength Steels (HSS)
- Advanced High Strength Steels (AHSS)
- Press Hardened Steels (PHS)
- Fiber Reinforced Plastics (FRP)



High-strength steel body + pedestrian protection + collapsible impact energy absorber system

All round 6 airbags, super area protection



AQS air quality management system

Integrated anion air purifier

* AQS air quality management system and integrated anion air purifier are standard configurations for 4WD model

Pre-warning and auto brake system

The intelligent technology provides you with pre-warning and safety protection, creating a colorful car life

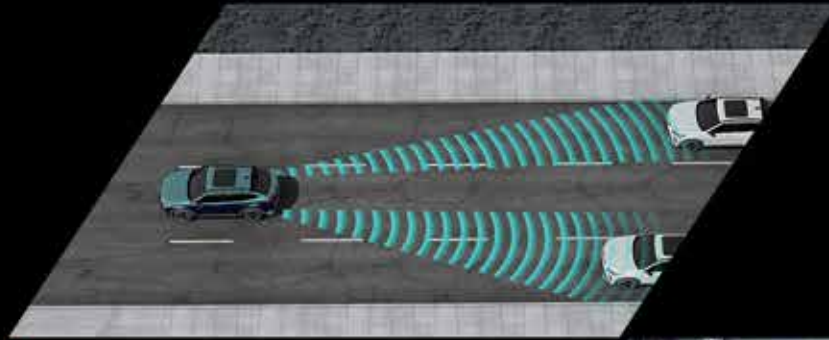

 Parallel assist + Reversing warning



 Front collision warning + Automatic emergency braking (FCW+AEB)

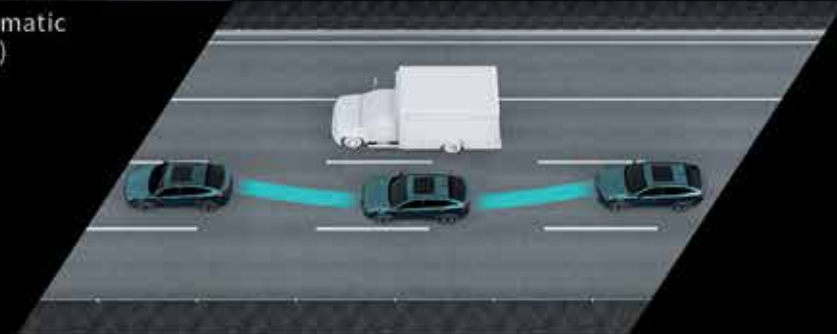

 Intelligent evasion and recognition of extra-long trucks help keep a safe distance

* The above configurations are not for standard configurations of all models. See the product configuration list for details

Body color



Atlantis Blue



Crystal Blue



Black



Red



White



Ayers Grey



KU Grey

Body dimensions



Front track: 1631 mm



Vehicle height: 1729 mm



Wheelbase: 2738 mm
Vehicle length: 4727 mm



Rear track: 1640 mm
Vehicle width: 1940 mm



Vehicle height: 1729 mm

H6GT Parameter configuration

Length × Width × Height (mm)	4727×1940×1729			
Wheelbase (mm)	2738			
Powertrain	2.0T			
Transmission	7DCT			
Emission standard	Euro V			
Drive mode	2WD		4WD	
Configuration level	Loaded version	Top configuration	Loaded version	Top configuration
Chassis steering				
Electronic gear shifter	●	●	●	●
Electrical Park Brake (EPB)	●	●	●	●
Auto hold	●	●	●	●
Front ventilated disc/Rear disc brake	●	●	●	●
Driving mode - 2WD (Standard/Sport/Eco/Snow/Track)	●	●	●	●
Driving mode - 4WD (Optional driving mode + All terrain feedback system)	×	×	●	●
Exhaust Sound Wave System	●	●	●	●
Smart start-stop	●	●	●	●
235/55 R19 tyres	●	●	●	●
235/55 R19 tyres (Michelin)	×	○	×	○
235/55 R19 tyres (Goodyear)	×	○	×	○
T135/90 R17 (conventional tyres)	●	●	●	●
Exterior Configuration				
Power trunk with delayed closing and memory	●	×	●	×
Inductive power trunk	×	●	×	●
Front boneless wiper	●	●	●	●
Inductive wiper	●	●	●	●
Top-mounted luggage rack	●	●	●	●
Panoramic sunroof	○	○	○	○
Shark fin antenna	●	●	●	●
Interior Configuration				
Microfiber leather steering wheel	●	●	●	●
Steering wheel paddle shifters	●	●	●	●
4-Way manually adjustable steering wheel	●	●	●	●
Electric heating of steering wheel	×	○	×	○
Vanity mirror + lighting	●	●	●	●

Wireless charging	×	●	×	●
Roof grab handle	●	●	●	●
Curtain	●	●	●	●
Automatic bi-zone air conditioner	●	●	●	●
Integrated anion air purifier	×	○	×	○
Seat configuration				
Vegan leather seat	●	●	●	●
6-Way electric adjustable driver seat	●	●	●	●
2-Way electric waist supporter driver seat	○	●	○	●
Ventilation of driver and front passenger seats	○	●	○	●
Electric heating for front seats	○	○	○	○
Ventilation for front seats	○	●	○	●
Middle headrest of rear seats	●	●	●	●
Active and Passive Safety				
Front double airbags	●	●	●	●
Front side airbag	●	●	●	●
Side curtain airbag	○	●	○	●
Front dual pre-tensioning force-limiter seat belt	●	●	●	●
Second middle three-point seat belt	●	●	●	●
Driver/passenger seatbelt warning	●	●	●	●
Electronic Stability Program (ESP)	●	●	●	●
Traction Control System (TCS)	●	●	●	●
Rear Collision Warning (RCW)	○	●	○	●
Roll Movement Intervention (RMI)	●	●	●	●
Hydraulic Brake Assist (HBA)	●	●	●	●
Hill Descent Control (HDC)	●	●	●	●
Hill-start Assist Control (HAC)	●	●	●	●
Brake Override System (BOS)	●	●	●	●
Emergency brake warning	●	●	●	●
Tyre Pressure Monitoring System (TPMS)	●	●	●	●
USB power interface of event data recorder	●	●	●	●
Front sensors	●	●	●	●
Parking sensors	●	●	●	●
360° panoramic view	○	●	○	●
Fully automatic fusion-based parking assist system	×	●	×	●
Adaptive Cruise Control (ACC) + Start-stop system	○	●	○	●







Intelligent coming brake control	○	●	○	●
Front Collision Warning + Automatic Emergency Braking (FCW+AEB)	○	●	○	●
Lane Departure Warning (LDW)	○	●	○	●
Lane Keeping Assist (LKA)	○	●	○	●
Lane Centering Keeping (LCK)	○	●	○	●
AEB - Pedestrian/Cyclist	○	●	○	●
Traffic Sign Recognition (TSR)	○	●	○	●
Rear Cross Traffic Alert (RCTA)	○	●	○	●
Cross Traffic Braking (CTB)	○	●	○	●
Rear Collision Warning (RCW)	○	●	○	●
Door Opening Warning (DOW)	○	●	○	●
Traffic Jam Assist (TJA)	○	●	○	●
Intelligent Cruise Assistance (ICA)	○	●	○	●
Intelligent Evasion (IE)	×	●	×	●
Emergency Lane Keeping (ELK)	×	●	×	●
Driver fatigue monitor system	●	●	●	●
Overspeed alarm	○	●	○	●
ISOFIX	●	●	●	●
Anti-theft Device				
Smartkey (two)	●	●	●	●
Keyless entry of driver and front passenger seats	●	●	●	●
Start/Stop button	●	●	●	●
Vehicle search function	●	●	●	●
Engine immobilizer	●	●	●	●
Anti-theft alarm system	●	●	●	●
Remote center lock	●	●	●	●
Automatic unlocking for collision	●	●	●	●
Function of automatically returning to armed status	●	●	●	●
Anti-accidental lock function	●	●	●	●
Door ajar alarm	●	●	●	●
Recreation				
Trip computer	●	●	●	●
10.25" colored instrument cluster	●	●	●	●
Adjustable brightness of instrument panel	●	●	●	●
Radio FM/AM	●	●	●	●
Bluetooth hands-free telephon	●	●	●	●
10.25" colored multi-touch screen	●	×	●	×
12.3" colored multi-touch screen	×	●	×	●

Front USB (with data transmission) + Rear USB (without data transmission)	●	●	●	●
E-CALL	○	○	○	○
4 high-pitch + 4 bass loudspeakers + DTS	●	●	●	●
Speed-dependent volume control	●	●	●	●
Wired CarPlay & Android Auto	●	●	●	●
W-HUD	×	●	×	●
Glass/rearview mirror				
Rear privacy glass	○	○	○	○
Electronic anti-glare interior mirror	●	●	●	●
One-button anti-clip lifting windows for four doors	●	●	●	●
Electric window	●	●	●	●
Electric adjustment of exterior rearview mirror	●	●	●	●
Electrical folding of exterior rearview mirror (with turn lamp)	●	●	●	●
Automatic folding of exterior rearview mirrors after vehicle locking	●	●	●	●
Exterior rearview mirror floor lamp	●	●	●	●
Defroster with heating wires (rear windshield)	●	●	●	●
Lighting configuration				
LED headlamp/tail lamp	●	●	●	●
Electric height-adjustable headlamp	●	●	●	●
Automatic headlamps + "Follow Me Home"	●	●	●	●
Front and Rear fog lamp (LED)	●	●	●	●
Steering assist lighting (fog lamp)	●	●	●	●
Daytime running lamp (LED-integrated)	●	●	●	●
High-mounted brake lamp (LED)	●	●	●	●
LED reading lamp+LED trunk lamp	●	●	●	●
Side ceiling lamp	●	●	●	●
Single-color ambient lamp	×	●	×	●
Basic information				
"●" stands for standard configuration; "×" for no such a configuration; "○" for optional configuration.				
The catalog is prepared based on the vehicle configurations at the time of printing. As GWM continuously modifies and improves the vehicle, some configurations and specifications of the models in the market may be different from those in this catalog. For details, please consult local franchised dealers. The catalog is subject to change without prior notice.				

GT



we're here for YOU

 Weg Naar Welgelegen 38 |  462.7444 | Saliña 196 |  starcuracao.com |  sales@starcuracao.com |
  [starcuracao](#) | [havalcuracao](#)

This brochure is for reference only. For actual details, please check the vehicles at local dealers.